

# Rueda Stick

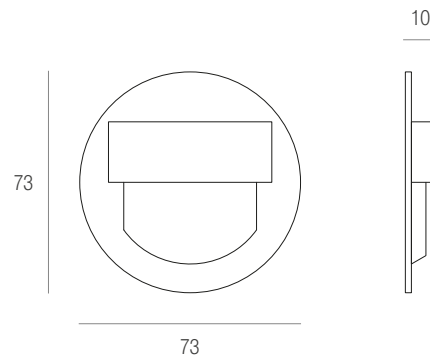

## Specifications



	INDEX	Color	Power	Beam	CCT	lm	lm/W	IP	IK	KG
<b>MH-RST-G-W-1-PL-00-01</b>		G	0,8 W	W	6000 K	32	40	66	09	0,059
<b>MH-RST-G-H-1-PL-00-01</b>		G	0,8 W	WW	3000 K	28	35	66	09	0,059
<b>MH-RST-G-B-1-PL-00-01</b>		G	0,8 W	B	-	-	-	66	09	0,059
<b>MH-RST-D-W-1-PL-00-01</b>		D	0,8 W	W	6000 K	32	40	66	09	0,059
<b>MH-RST-D-H-1-PL-00-01</b>		D	0,8 W	WW	3000 K	28	35	66	09	0,059
<b>MH-RST-D-B-1-PL-00-01</b>		D	0,8 W	B	-	-	-	66	09	0,059
<b>MH-RST-C-W-1-PL-00-01</b>		C	0,8 W	W	6000 K	32	40	66	09	0,059
<b>MH-RST-C-H-1-PL-00-01</b>		C	0,8 W	WW	3000 K	28	35	66	09	0,059
<b>MH-RST-C-B-1-PL-00-01</b>		C	0,8 W	B	-	-	-	66	09	0,059
<b>ML-RST-G-W-1-PL-00-01</b>		G	0,8 W	W	6000 K	32	40	20	09	0,059
<b>ML-RST-G-H-1-PL-00-01</b>		G	0,8 W	WW	3000 K	28	35	20	09	0,059
<b>ML-RST-G-B-1-PL-00-01</b>		G	0,8 W	B	-	-	-	20	09	0,059
<b>ML-RST-D-W-1-PL-00-01</b>		D	0,8 W	W	6000 K	32	40	20	09	0,059
<b>ML-RST-D-H-1-PL-00-01</b>		D	0,8 W	WW	3000 K	28	35	20	09	0,059
<b>ML-RST-D-B-1-PL-00-01</b>		D	0,8 W	B	-	-	-	20	09	0,059
<b>ML-RST-C-W-1-PL-00-01</b>		C	0,8 W	W	6000 K	32	40	20	09	0,059
<b>ML-RST-C-H-1-PL-00-01</b>		C	0,8 W	WW	3000 K	28	35	20	09	0,059
<b>ML-RST-C-B-1-PL-00-01</b>		C	0,8 W	B	-	-	-	20	09	0,059

### Use

For illumination of circulation routes, stairs, stair risers, cabinet fronts, or for attractive light decoration of walls.

### Finishing



### Colour of light



### Regulatory compliance

PN-EN 60598-1:2015-04, PN-EN 60598-2:2012, PN-EN 62471:2010, PN-EN 62031:2010, PN-EN 62031:2010/A2:2015-04, PN-EN 62031:2010/A1:2013-06

### Further information

**Material:** aluminum

**Light source:** non-exchangeable LED modules







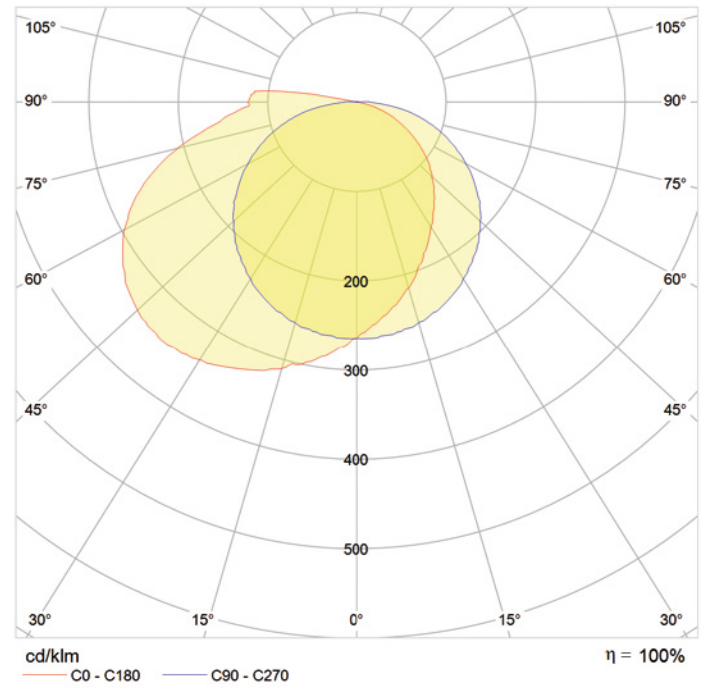























































**Method of installation:** with adhesive tape or glue

**Warranty:** 36 months

### Chart photometric



## Key to symbols

	Floor wide angle lights		Champagne		Tightness
	Built-in furniture wide angle lights		Transparent		Resistance
	Built-in furniture narrow angle lights		Colour of light		Protection class I
	Overhead furniture wide angle lights		Blue		Protection class II
	Overhead furniture narrow angle lights		Neutral		Protection class III
	Furniture lights mounted on glazing		Cool white		Device independent of lamps
	Built-in wide angle lights		Warm white		Short-circuit and overload proof safety transformer
	Overhead wide angle lights		Rated power		SELV protection
	Wall-mounted wide angle lights		LED power		Min. distance from illuminated item
	Hanging wide angle lights		Fixture power		Weight
	Surface Finishing		DC voltage		Single LED tape module dimensions
	Stainless steel (INOX)		AC voltage		Min. operating temperature
	Chrome plating		LED light flux		Max. operating temperature
	White		Luminaire light flux		Constant current
	Black		Luminous efficacy luminaire		Constant voltage
	Aged brass		LED Light source		PF (Power Factor)
	Aluminium		Replaceable Light source		Input voltage
	Brushed nickel (INOX)		Energy efficiency class - LED		Output voltage
	Brushed stainless steel (INOX)		Energy efficiency class - replaceable light sources		Compatibility with intelligent home systems
	Mirror (INOX)		Colour rendering index		Dimming options
	Matte brass		Colour temperature		No dimming

## Key to symbols

---



Compliance with RoHS



Compliance with CE Directive



SKOFF item no.



3M technology is implemented in the product